



P.H.A.'R AODD MODELS FT20A & FT20S

Assembly, Installation, & Operation Manual

P/N 109787-7



Record your Model and Serial Number here.

MODEL NUMBER _____

SERIAL NUMBER _____

Table of Contents

Important Information - READ ME FIRST

Export Regulation Notice	3
Chemical Reaction Disclaimer	3
Safety Precautions	3-4

Pump Specifications

Materials Profiles.....	5
Technical Specifications	5
FT20S Dimensional Drawing.....	6
Model Number Explanation & Example Part Numbers.....	6
FT20A Dimensional Drawing.....	7
Performance Curve.....	7

Installation/Operation

Installation Drawing.....	8
Precautions.....	8-9
Troubleshooting.....	9

Maintenance

Recommended Tools	9
Wet End Servicing	9
Disassembly	10-11
Reassembly	12-15
Air End Servicing	15
Shaft Bushing & O-ring Replacement.....	15-16
Air Valve O-ring Replacement.....	16-17
Valve & Muffler Gasket Replacement.....	17-18
Air Valve Slide, Plate, & Gasket Orientation.....	18
Replacement Air Valve Kit Installation.....	19
Exploded View	19
Spare Parts List.....	19-22

Warranty	23
-----------------------	-----------

Important Information- Read Me first

IMPORTANT NOTICE

U.S. Export Administration Regulations, pursuant to ECCN 2B350, prohibit the export or re-export to certain enumerated countries of air operated double diaphragm pumps in which all wetted materials are constructed from fluoropolymers without first applying for and obtaining a license from the U.S. Bureau of Industry and Security (BIS). This affects all P.H.A.'R pumps constructed from PVDF with PTFE balls and diaphragms. Please contact the BIS (www.bis.doc.gov) or P.H.A.'R with questions regarding the Regulations or a list of the countries to which they apply.

Chemical Reaction Disclaimer

The user must exercise primary responsibility in selecting the product's materials of construction which are compatible with the fluid(s) that come(s) in contact with the product. The user may consult P.H.A.'R and a manufacturer's representative/distributor agent to seek a recommendation of the product's material of construction that offers the optimum available chemical compatibility.

However neither manufacturer nor agent shall be liable for product damage or failure, injuries, or any other damage or loss arising out of a reaction, interaction or any chemical effect that occurs between the materials of the product's construction and fluids that come into contact with the product's components.

Unpacking & Inspection

Unpack the pump and examine for any signs of shipping damage. If damage is detected, save the packaging and notify the carrier immediately.

To install the pump, follow the installation instructions provided.

Safety Precautions for ATEX Pumps

⚠ Warning: READ THIS SUPPLEMENTAL INSERT COMPLETELY BEFORE INSTALLING AND OPERATING THIS PUMP. FAILURE TO FOLLOW THESE PRECAUTIONS CAN RESULT IN SERIOUS INJURY OR DEATH.

⚠ WARNING: Static sparking can cause explosion. When operating in a hazardous area or pumping a hazardous fluid, the pump's grounding screw and entire pump system must be grounded to earth to prevent static discharge. This includes but is not limited to pipes, hoses, tanks, containers, valves, etc. Before operating the pump, ensure the electrical continuity throughout the pumping system and earth ground is 1 Ohm or less. If it is greater than 1 Ohm, re-check all grounding connections.

⚠ WARNING: Static sparking can cause explosion. Excessive fluid flow rates and improper tank filling methods can produce static electricity causing an explosion. Ensure safe fluid velocities and tank filling procedures in compliance with EN 13463-1 and CLC/TR 50404.

⚠ WARNING: Vibrations from operation may cause mounting surfaces and connections to loosen and generate a spark. Ensure the pump and connections are securely mounted and fastened prior to each operation.

⚠ WARNING: Do not exceed minimum and maximum temperature limits of pump components. A table of temperature limits is provided in the "Pump Data" section of the manual.

⚠ WARNING: Prior to operating, check pump for any worn o-rings, gaskets, or seals. Any leaking or damaged o-rings, gaskets, or seals must be repaired or replaced immediately.

⚠ WARNING: Do not exceed maximum pressure stated on the pump serial number sticker.

⚠ WARNING: Pump exhaust may be loud and contain particles. Wear appropriate ear and eye protection. In the event of a diaphragm rupture material can be forced out of the air exhaust muffler. If product is hazardous or toxic, pipe exhaust to appropriate safe area.

⚠ WARNING: Pump must be cleaned on a regular basis to avoid dust buildup greater than 5mm.

⚠ WARNING: The surface temperature of the pump depends upon the temperature of the fluid that is being pumped. The chart below lists different fluid temperatures and the corresponding pump surface temperatures, which determine the Temperature Class when used in a hazardous area.

Fluid Temperature	Maximum Surface Temperature	Temperature Class	Maximum Allowable Surface Temperature
172° F (78° C)	172° F (78° C)	T6	85° C
203° F (95° C)	203° F (95° C)	T5	100° C
266° F (130° C)	266° F (130° C)	T4	135° C
383° F (195° C)	383° F (195° C)	T3	200° C

Safety Precautions

⚠ WARNING: P.H.A.'R maximum temperature limits are based upon the material's mechanical stress only. Maximum temperature is application dependent. Consult a chemical resistance guide or the chemical manufacturer for chemical compatibility and temperature limits.

⚠ WARNING: Chemical Hazard. This pump is used for transferring many types of potentially dangerous chemicals. Always wear protective clothing, eye protection and follow standard safety procedures when handling corrosive or personally harmful materials. Proper procedures should be followed for draining and decontaminating the pump before disassembly and inspection of the pump. There may be small quantities of chemicals present during inspection.

⚠ WARNING: Hot surfaces. P.H.A.'R pumps are capable of handling liquids with temperatures as high as 220°F (104°C). This may cause the outer areas of the pump to become hot as well and could cause burns.

⚠ WARNING: If a diaphragm rupture occurs, material being pumped may be forced out of the air exhaust. Proper care should be taken, always wear protective clothing, eye protection & follow standard safety procedures.

⚠ WARNING: When pumping hazardous liquids, or operating the pump in an enclosed room, it is important to pipe the exhaust air to a safe area.

⚠ WARNING: For polypropylene or PVDF pumps do not exceed 100 psig (6.9 bar) air supply & 120 psig (8.3 bar) for aluminum and stainless steel.

⚠ CAUTION: Before attaching air supply to pump to make sure all airline debris is clear. It is recommended to use a minimum 5µ (micron) air filter before the air valve.

⚠ CAUTION: Do not over-tighten the air inlet fitting or muffler. Too much torque could damage the air valve or muffler plate.

⚠ CAUTION: Before maintenance or repair, close the compressed air line supply valve, bleed the pressure and disconnect air line from the pump. Discharge line may also be pressurized. Any pressure must be relieved prior to servicing. Remove suction / discharge lines & drain the pump.

⚠ CAUTION: If pump is used with materials that tend to solidify or settle, the pump should be flushed after each use to prevent damage.

⚠ CAUTION: Use only genuine P.H.A.'R replacement parts to assure compatibility & longest service life.

⚠ CAUTION: Check the temperature limits for all wetted components when choosing pump materials. See Materials Profiles table on page 7.

⚠ EXPLOSION HAZARD! P.H.A.'R pumps with standard materials of construction should not be used with halogenated hydrocarbons. Halogenated hydrocarbon solvents can cause explosion when used with aluminum components in a closed (pressurized) system. P.H.A.'R pumps with standard materials of construction contain aluminum components and will be affected by halogenated hydrocarbon solvents.

1-1-1 Trichloroethane and Methylene Chloride are the most common halogenated hydrocarbons. However, other halogenated hydrocarbon solvents are suspect if used either as part of paint or adhesive formulation, or for clean-up flushing. For applications that may involve halogenated hydrocarbons, contact P.H.A.'R to discuss the availability of alternative pump materials of construction.

Material Profiles

Material	Chemical Composition	Description	Operating Temperature	
			Minimum	Maximum
Polypropylene	Pure Polypropylene	Thermoplastic that is resistant to alkali and strong acids.	32°F (0°C)	158°F (70°C)
PVDF	Pure Polyvinylidene Fluoride	Strong fluoropolymer with excellent chemical resistance.	10°F (-12°C)	220°F (104°C)
Stainless Steel	316 Stainless Steel	Excellent chemical resistance, high tensile and impact strength, abrasion resistant.	Limited by other materials used	
Aluminum	ADC 12, LM24, LM25	Moderate chemical resistance with good impact strength and abrasion resistance.	Limited by other materials used	
Buna	Acrylonitrile-butadiene Rubber	General purpose elastomer. Resistant to oil, water, solvent, and hydraulic fluid.	10°F (-12°C)	190°F (88°C)
EPDM	Ethylene Propylene Diene Rubber	Good resistance to mild acids, detergents, alkalis, ketones, and alcohols.	-40°F (-40°C)	250°F (121°C)
FKM	Fluorocarbon Rubber	Good chemical resistance and high temperature properties. Resistant to most acids, aliphatic, aromatic, and halogenated hydrocarbons, oils, grease, and fuels.	-40°F (-40°C)	350°F (177°C)
Neoprene	Chloroprene Rubber	General purpose elastomer with good resistance to moderate chemicals, oils, grease, solvents, and some refrigerants.	0°F (-18°C)	212°F (100°C)
Santoprene™	Fully cured EPDM rubber particles encapsulated in a polypropylene (PP) matrix	Thermoplastic elastomer with good abrasion resistance with chemical resistance to a wide range of solvents and chemicals. Injection molded with no fabric layer.	-40°F (-40°C)	225°F (107°C)
Hytrel®	Thermoplastic polyester elastomer	Combines resistance and flexibility of elastomers with the strength of plastics. Resistant to acids, bases, amines, and glycols. Injection molded with no fabric layer.	-20°F (-29°C)	220°F (104°C)
Polyurethane	Polyester Urethane	Thermoplastic that exhibits excellent abrasion resistance. Injection molded with no fabric layer.	32°F (0°C)	150°F (66°C)
PTFE	Polytetrafluoroethylene	Chemically inert. Resistant to a wide range of chemicals.	40°F (4°C)	225°F (107°C)
FEP	Fluorinated Ethylene Propylene	Similar to PTFE in composition and chemical resistance. Used to encapsulate FKM o-rings for superior chemical resistance.	40°F (4°C)	225°F (107°C)

Santoprene™ is a registered tradename of Exxon Mobil Corp.
Hytrel® is a registered tradename of Dupont™

Specifications

Pump Type: Metallic Air Operated Double Diaphragm	
Weight:	Aluminum - 87.0 lbs (39.5 kg) 316SS - 130 lbs (59.0 kg)
Air Inlet/Exhaust Size:	3/4" FNPT
Max Air Inlet Pressure:	120 psig (8.3 bar)
Max Material Inlet Pressure:	10 psig (0.7 bar)
Air Consumption @ 100 psi:	100 scfm (170 Nm ³ /hr)
Noise Level:	77 dB(A)
Max Suction Lift:	Wet - 28 ft H ₂ O (8.5 m H ₂ O) Dry - 13 ft H ₂ O (4.0 m H ₂ O)
Max Flow Rate:	156 gpm (590 lpm)
Suction/Discharge Size:	2" FNPT/FBSP
Max Particle Size:	0.35" (8.9 mm)
Max Outlet Pressure:	120 psig (8.3 bar)
Displacement Per Stroke:	0.31 gal (1.2 liter)

FT20S Dimensional Drawing

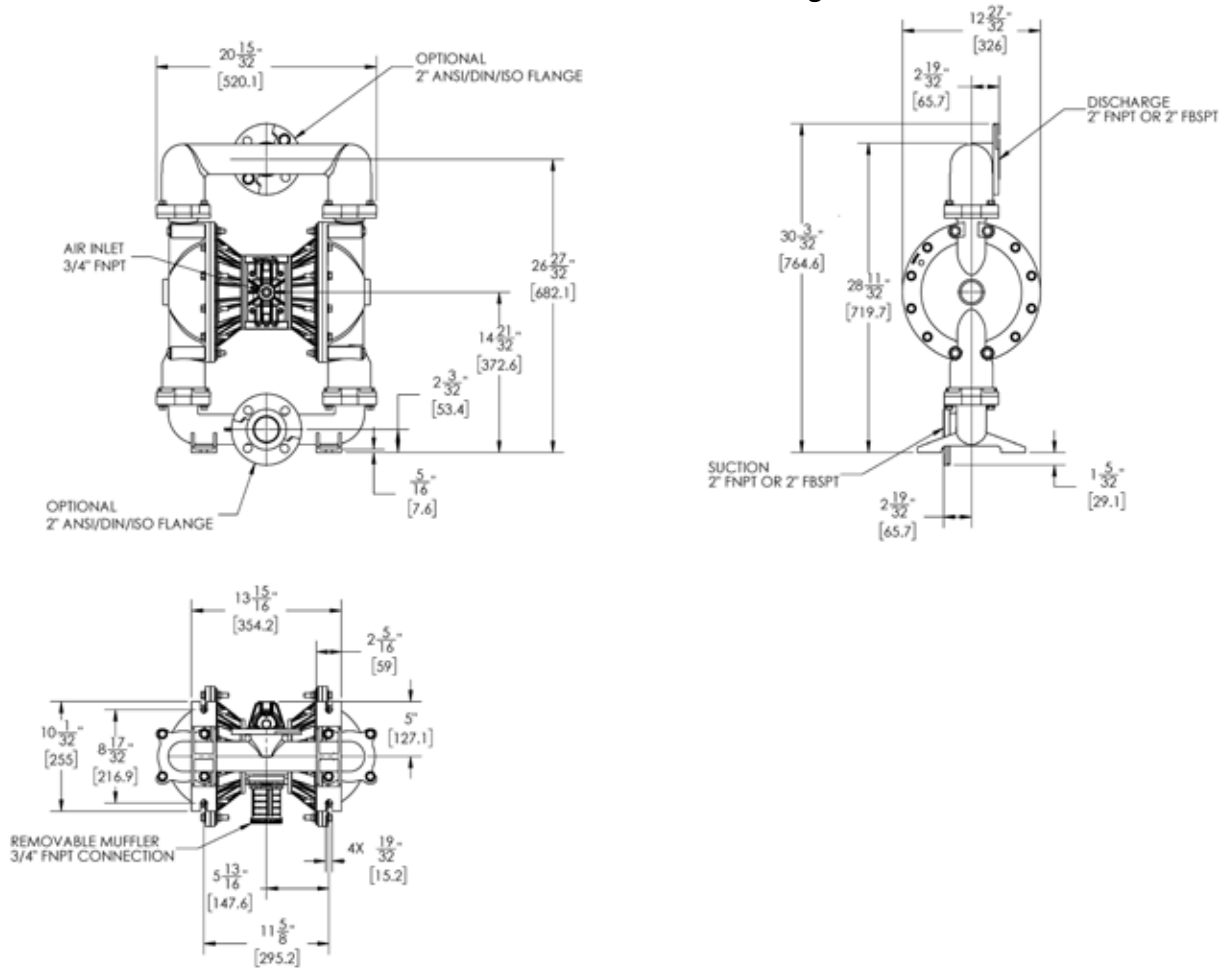

Model Number Explanation & Example Part Numbers

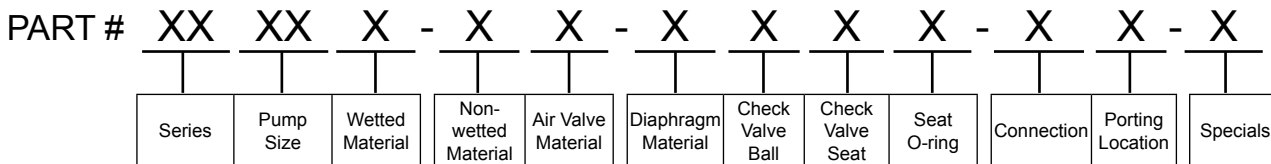

Series*

FT - Pump End
FW - Wet End

Pump Size*

20 - 2"

Wetted Materials*

A - Aluminum
S - 316SS

Non-wetted Materials

P - GFRPP A - Aluminum**

Air Valve Materials

P - GFRPP A - Aluminum**

Diaphragm Materials*

N - Neoprene H - Hytrel
B - Buna-N U - Polyurethane
E - EPDM 1 - PTFE/Neoprene
F - FKM 2 - PTFE/Santoprene
R - Santoprene

Check Valve Ball Materials*

N - Neoprene F - FKM
B - Buna-N R - Santoprene
E - EPDM T - PTFE

Check Valve Seat Materials*

A - Aluminum S - 316SS
T - PTFE B - Buna-N
F - FKM E - EPDM
R - Santoprene H - Hytrel
N - Neoprene U - Polyurethane

Check Valve Seat O-Ring Materials*

N - Neoprene F - FKM
B - Buna-N E - EPDM
C - FEP/FKM O - None
T - PTFE

Connection

N - FNPT B - FBSP
F - ANSI/DIN/ISO Flange

Porting location

2 - Center horizontal

Specials

A - ATEX
M1 - Metal muffler

*Required for wet end

**Required for ATEX

Example Pump P/N's: FT20A-AA-NNAN-N2, FT20A-PP-BBAB-B2, FT20S-AA-1TST-F2, FT20S-PP-EESE-B2

Example Wet End P/N's: FW20A-NNAN, FW20A-BBAB, FW20S-1TST, FW20S-EESE

FT20A Dimensional Drawing

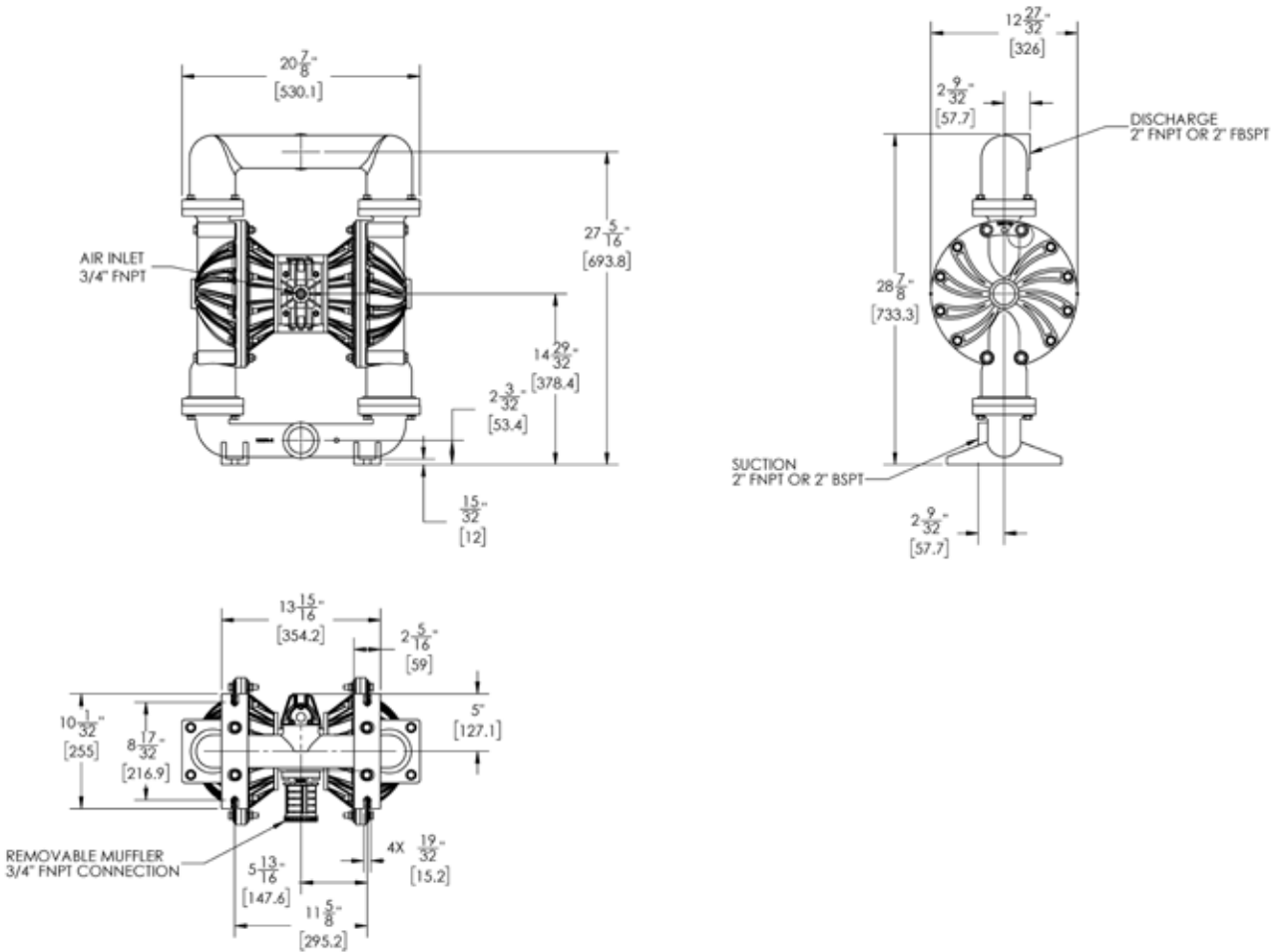

FT20S & FT20A Performance Curve

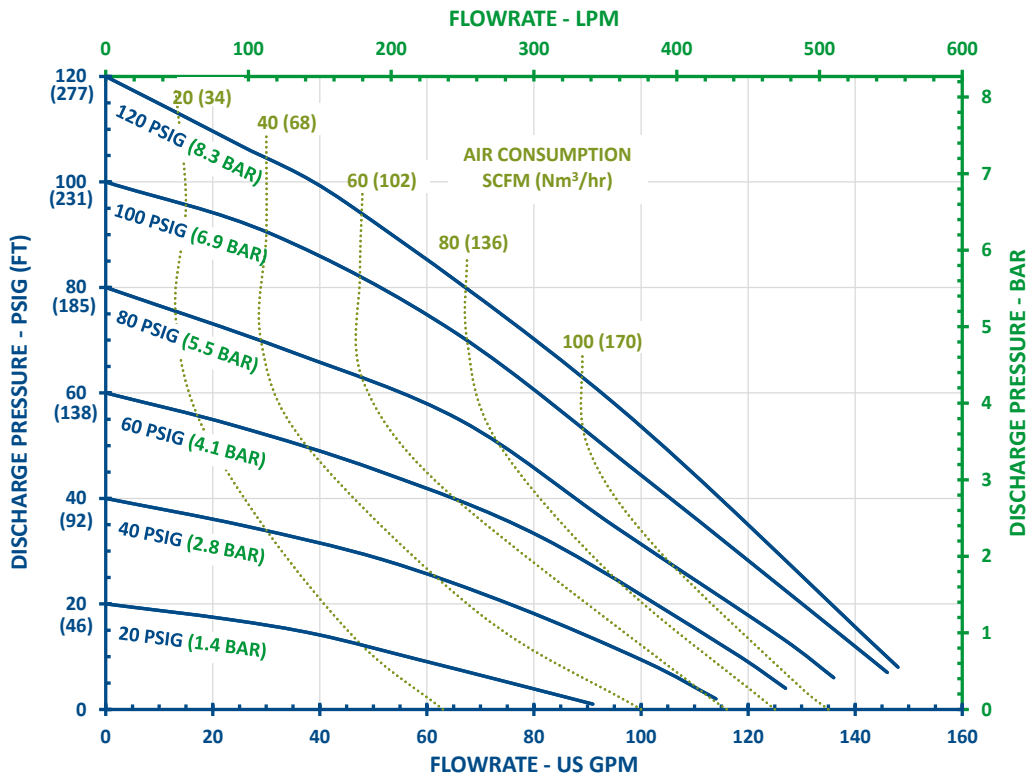

Installation Drawing

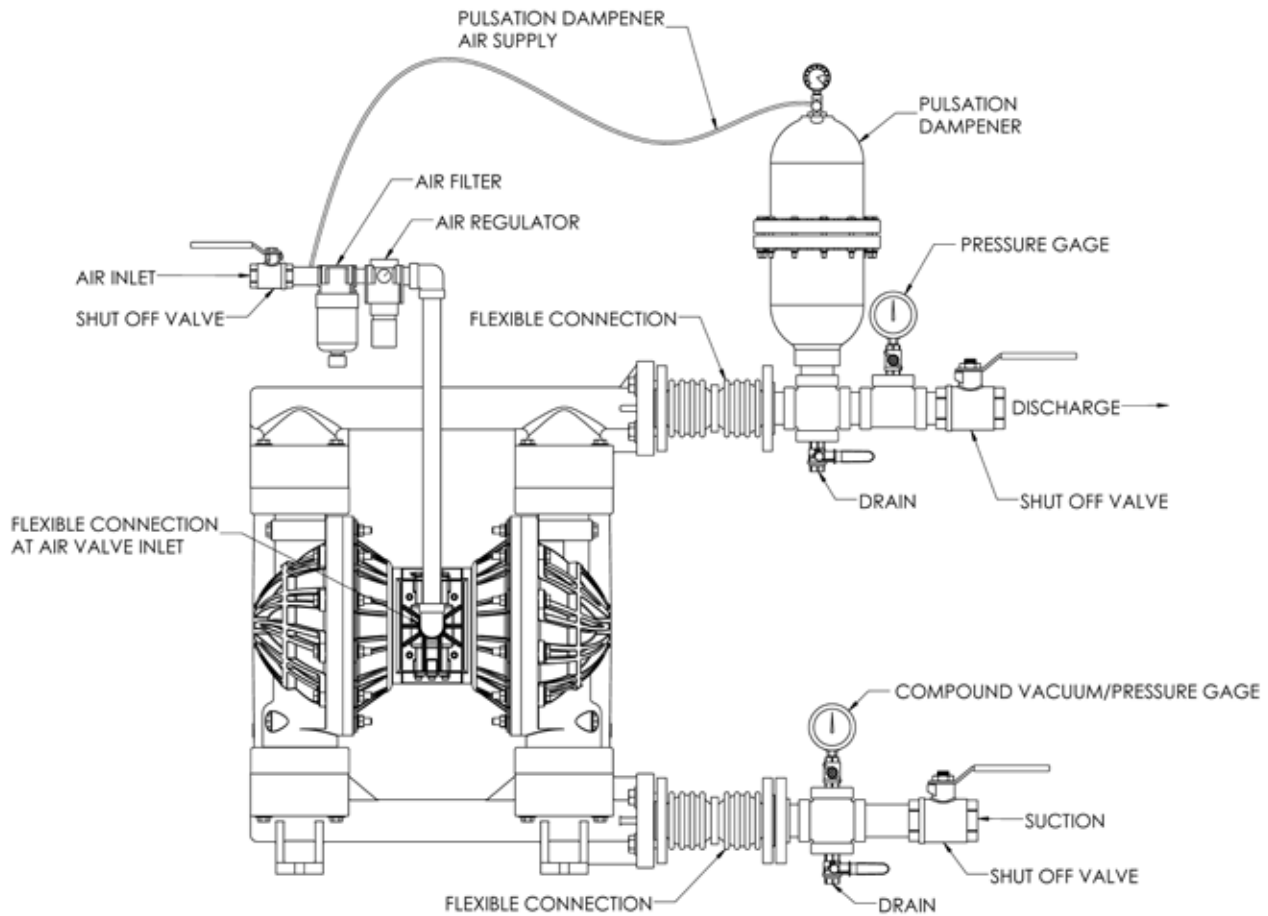

PUMP MUFFLER IS ON THE BACK SIDE OF THE PUMP.
IT CAN BE REMOVED AND EXHAUST CAN BE PIPED TO DESIRED LOCATION.

Installation / Operation Precautions

Installation and Start up

Install the pump in a vertical position or it may not prime properly. Pump should be located as close to the product being pumped as possible. Suction line length should be as short as possible and limit the number of fittings. Suction line diameter should not be reduced smaller than the suction diameter of the pump. When using rigid pipe run short sections of flexible hose or flexible connections between the pump & piping. Secure the pump to a suitable surface.

Air Supply

Connect the pump air inlet to an air supply with sufficient capacity to achieve desired performance. A pressure regulating valve should be installed to insure air supply pressure does not exceed recommended limits.

Air Valve Lubrication

No lubrication is required for the air distribution system.

Fasteners

Re-torque all fasteners before operation. Creep of housing and gasket materials may cause fasteners to loosen. Re-torque all fasteners to the torque specifications listed on the exploded view drawing in this manual.

Air Inlet & Priming

Pump will start to operate as soon as the shut-off valve is opened. It is recommended to open the shut-off valve slowly at first. Once the pump primes; the shut-off valve can be opened additionally to increase the pump's flow. If the pump is operating but not pumping any liquid see the troubleshooting section for tips & suggestions.

Accessories

Surge suppressors, spill stops & filter regulators are available and should be used with P.H.A.'R pumps.

Troubleshooting Tips & Suggestions

PUMP WILL NOT START OR CYCLE:

- Blocked liquid pipe or hose - Clean out or replace
- Clogged liquid chamber - Remove debris
- Diaphragm shaft bushing / o-ring leak - Replace o-rings
- Air valve carrier not shifting - Inspect, clean, re-oil with 10 wt. air tool oil. (aluminum air valve)
- Air valve carrier not shifting - Inspect, replace seals (polypropylene air valve)

ERRATIC CYCLING:

- Diaphragm failure - Replace diaphragm
- Valve ball not seating properly, worn or damaged – Inspect, remove debris or replace
- Leak in suction line - Inspect, repair or replace
- Diaphragm shaft bushing / o-ring leak - Replace o-rings
- Air valve carrier not shifting - Inspect, clean, re-oil with 10 wt. air tool oil. (aluminum air valve)
- Air valve carrier not shifting - Inspect, replace seals (polypropylene air valve)
- Over lubrication in air valve - Inspect, degrease, reuse. Adjust lubrication
- Excess moisture in air valve – Inspect, dry, reuse. Consider installing an air dryer
- For aluminum air valves, worn carrier or valve bore – measure carrier and valve bore, diametrical clearance should be between .0020” - .0035”. Replace worn components as needed
- For plastic air valves, worn carrier seals – replace carrier seals if there is no longer interference between seals and valve bore

PUMP CYCLES BUT WILL NOT PUMP:

- Too much suction lift - Reduce suction lift or fill liquid chambers with liquid
- Leak in suction line - Inspect, repair or replace
- Valve ball not seating properly, worn or damaged - Inspect, remove debris or replace
- Clogged suction pipe or hose - Inspect & clear
- Clogged strainer if used - Inspect & clear
- Diaphragm failure - Replace diaphragm

PUMPED LIQUID RELEASED FROM AIR EXHAUST

- Diaphragm failure - Replace diaphragm
- Outer plate unthreading - Tighten & re-torque

Maintenance

Recommended Tools for Servicing Pump

- 13 mm, 15 mm, & 17 mm box wrenches; (2) 30mm socket wrenches, snap ring pliers; 5, 6, & 8 mm hex wrenches, o-ring pick, & torque wrench.

Wet End Servicing (Installing Wet End Kit)

- Relieve airline pressure and fluid line pressures before conducting maintenance.
- The pump can be drained by turning it upside down and allowing fluid to drain into an appropriate container. Use proper safety equipment when conducting maintenance as internal components may still contain the pumped media.
- Lubricate all stainless steel to stainless steel fasteners to prevent galling. Torque values listed on page 25 of this manual are for lubricated fasteners.

Wet End Disassembly

1 Remove the (8) discharge manifold bolts (item 11) from the discharge manifold (item 39) using a 15mm wrench.



2 The discharge seat o-rings, valve seats and valve balls (items 13, 14, & 15) can now be accessed and replaced if needed.



3 Repeat the above steps for the suction manifold (item 12). The seat o-rings, valve seats and valve balls (items 13, 14, & 15) are located in the liquid chambers (item 18).

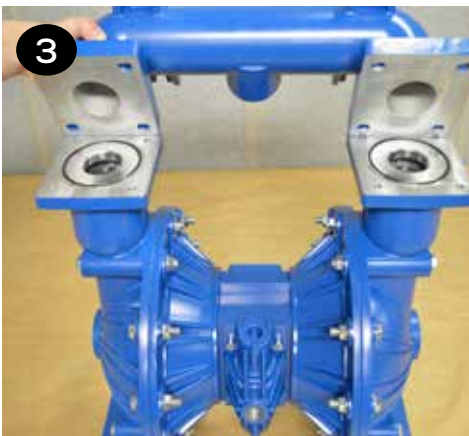

4 Remove both liquid chambers (item 18) by removing the (12) bolts & nuts (item 16, 17, & 27) on each liquid chamber using a 15 mm wrench. Inspect and replace diaphragms if needed.



5 To remove the diaphragms (items 21/22), begin by loosening the (2) outer plates (item 19) using two 30 mm wrenches. Use 6-sided sockets or wrenches to prevent damage to the hex portion of the outer plate.



6 Remove the outer plate, diaphragm(s), and inner plate (items 19, 21/22 & 23) from the side that is loosened. Pull or push the shaft (item 32) and remaining plates and diaphragms out of the center section. If pulling, it may be easier to grip the diaphragm if it is inverted.

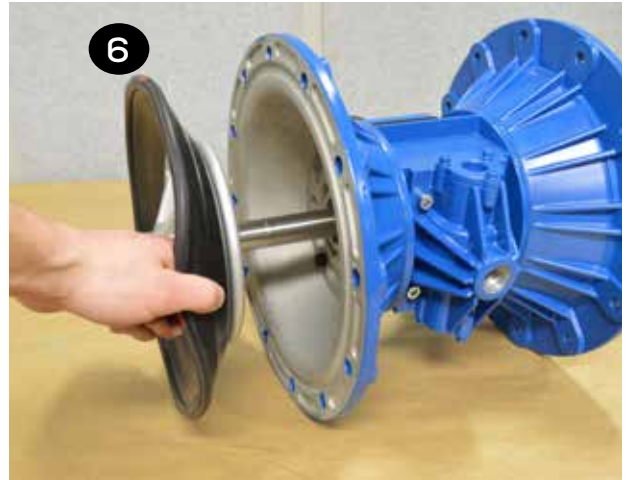

7 To remove the remaining diaphragm(s) (items 21/22) and plates (items 19 & 23) from the shaft (item 32), place the shaft in a vise. Using a 6-sided 30 mm wrench, remove the remaining diaphragm(s) and plates.



After performing required maintenance, the pump can be reassembled. The pump can also be reassembled using the disassembly instructions in the reverse order as listed above. For detailed assembly instructions, follow steps in Wet End Reassembly section beginning on page 14.

Wet End Reassembly

1 Slide the center hole of one diaphragm (item 22) over the cast/threaded bolt of an outer plate (item 19). The air side of the diaphragm is labeled and should face away from the outer plate.

If the pump is fitted with PTFE diaphragms (item 21), first place a PTFE diaphragm over the cast/threaded bolt of the outer plate (item 19). Then place the backup diaphragm (item 22) on the outer plate. The shape of the PTFE diaphragm and back up diaphragm should roughly conform to one another. See the exploded view drawing for proper orientation.



2 Place the inner plate (item 23) over the cast/threaded bolt. Ensure the round recess in the plate faces the diaphragm (item 22).

3 Place the bump stop (item 31) onto one end of the shaft (item 32).

4 Apply a couple drops of a medium strength thread locker, such as Loctite® 246, to the cast/threaded outer plate bolt (item 20). Thread the shaft (item 32) onto the bolt until it is snug to the flat back side of the inner plate (item 23).



5 The shaft (item 32) and shaft o-rings (item 30) should retain the lubricant that was factory applied. If they appear dry, apply a light coat of lithium thickened grease. Avoid over-lubrication as it can cause decreased performance of the air distribution system.



6 Push the shaft (item 32) through the center of the shaft bushing (item 29). It is normal for this to be a tight fit, especially if the shaft and shaft o-rings (item 30) are in good condition.



7 Place the remaining bump stop (item 31) on the other end of the shaft (item 32).



8 It may be easier to thread the bolt into the shaft if the diaphragm(s) is inverted on one or both sides. This can be done by hand.



9 The other diaphragm(s) (items 21/22) and inner/outer plates (items 19 & 23) can be installed onto the opposite end of the shaft (item 32).



10 Tighten and torque the outer plates (item 19). If the pump is fitted with PTFE diaphragms (item 21), it is necessary to restrict their ability to rotate when tightening the outer plates. This can be done by threading the liquid chamber bolts (item 16 & 17) through the PTFE diaphragm holes and into the center section (item 35) on each side. This will ensure that the PTFE diaphragm does not obstruct the bolts ability to thread into the center section when the liquid chambers are installed. Remove these bolts once the outer plates are torqued.



Note: When installing polytetrafluoroethylene (PTFE) diaphragms, it is important to tighten outer plates simultaneously (turning in opposite directions) to ensure tight fit.

11 Install the liquid chambers (item 18) by placing one side over the diaphragm. Start all bolts & nuts (items 16, 17, 27) before tightening and torquing. Torque all fasteners in a star pattern. Repeat to install the second liquid chamber. Ensure both chambers are orientated the same and that the inlet and outlet ports are vertical when facing the front of the pump as shown.



12 Flip the pump upside down and drop the suction valve balls (item 15) into the liquid chamber (item 18) ball cages.



13 For pumps fitted with metal or PTFE valve seats (item 14), place the valve seat o-rings (item 13) into the glands on both sides of the valve seat. Pumps fitted with rubber or TPE seats do not require valve seat o-rings. All seats are symmetrical, i.e. there is no top or bottom.



14 Place the valve seats (item 14) into the seat bore in the liquid chamber (item 18). Place the suction manifold (item 12) atop the pump, install, tighten and torque the (8) manifold bolts (item 11).



15 Stand the pump upright onto the suction manifold feet. Place the valve seat o-rings (item 13) into both sides of the valve seat. Place the seat on the liquid chamber (item 18). Place the valve balls (item 15) on the seats and discharge manifold (item 39) atop the components that are stacked on top of the liquid chambers. Install, tighten and torque the (8) manifold bolts (item 11).



Air End Servicing (Installing Air End Kit)

- Follow steps 1 – 7 in the Wet End Servicing disassembly section to access the shaft bushing (item 29) and o-rings (items 28 & 30), then follow steps below.

Shaft, Bushing, & O-ring Replacement

1 Remove both air chambers by removing the (4) bolts & washers (items 24 & 25) on each side of the pump with a 13mm wrench.



2 Remove and set aside the air valve (item 3) using a 6mm hex wrench (see Valve and Muffler Gasket Replacement section for more details). The shaft bushings can be removed by placing a large socket between the two bushings. Place an extension into the socket from one side of the center section. Tap with a rubber mallet to remove the bushing. Repeat for the remaining bushing.

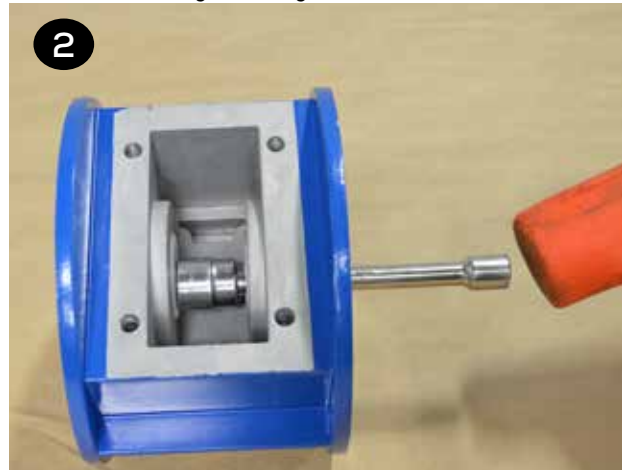

3 Use the supplied grease packets to lightly grease the OD and ID o-rings (items 28 & 30) that come preinstalled in the new shaft bushings supplied in air end kits.



4 Insert both bushings into the center section. Ensure the bushing is fully installed and the large rib on the outside of the bushing is flat against the center section.



5 Inspect the shaft (item 32) for damage. It is common for shafts to become grooved during service. Grooving is normally caused by carbonized oil and/or abrasive foreign material getting trapped between the seal and the shaft. Over time, deep grooves can form in the shaft. When that occurs, it is recommended that the shaft be replaced.



6 After determining if the condition of the shaft is acceptable, ensure both center section o-rings (items 33 & 34) are in place on both sides of the center section.



7 Install air chambers (item 26) by placing one side on top of the center section (item 35). Ensure the air path hole of the center section lines up with the through hole in the air chamber.



8 Tighten and torque the (4) fasteners (items 24 & 25) that connect the air chamber (item 26) to the center section (item 35). Repeat for the second air chamber.



• To rebuild the rest of the pump, follow steps 5 – 15 in the Wet End Servicing – Wet End Reassembly section.

Air Valve O-Ring Replacement

1 Plastic Air Valve - To replace the valve cap o-ring remove the retaining ring (item 8), then unthread the valve cap (item 6) using a 8 mm hex wrench.

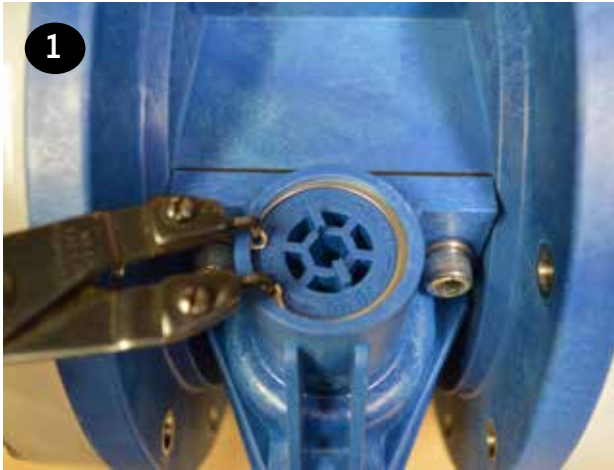

1 Aluminum Air Valve - To replace the valve cap o-rings (item 5), remove the (3) button head cap screws (item 7) using a 5 mm hex wrench.

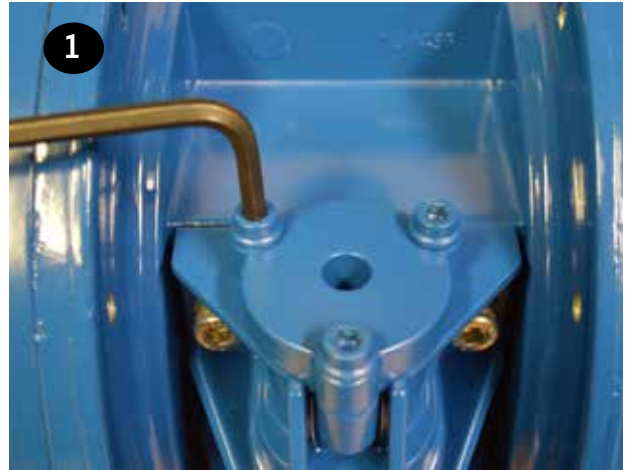

2 Plastic Air Valve - Remove and replace o-ring (item 5). Install cap (item 6) and tighten until groove for the retaining ring is visible. Install retaining ring.

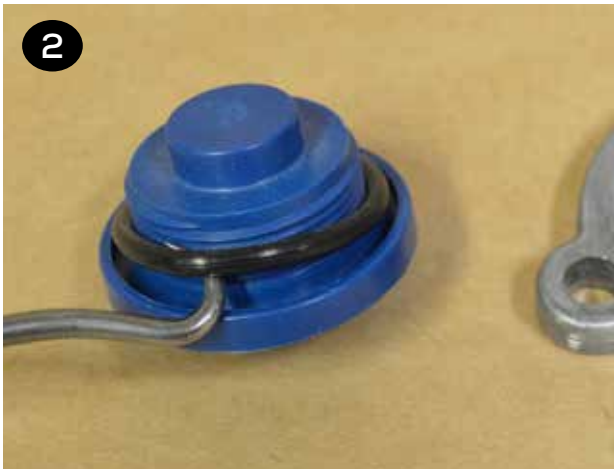

2 Aluminum Air Valve - Remove and replace o-ring (item 5). Install cap (item 6), tighten, and torque the valve cap screws (item 7). Repeat for the remaining cap.

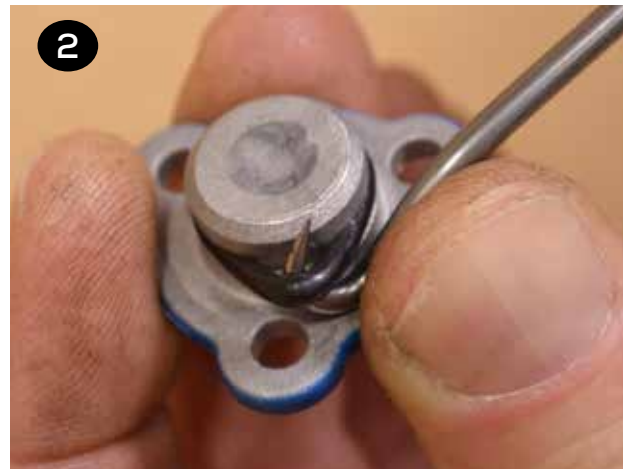

Valve and Muffler Gasket Replacement

❶ Remove the valve body (item 3) by removing the (4) socket head cap screws and washers (items 1 & 2) that attach the valve body to the muffler plate (item 38) with a 6 mm hex wrench



❷ Pull the valve body and gasket (items 3 & 36) off the front of the center section (item 35) and the muffler plate gasket, muffler plate and muffler (items 37, 38, & 40) off the back.



❸ Place the new gasket (item 38) on the air valve (item 3) and ensure the slots in the gasket align with the slots in the air valve and valve plate (item 10).

Air Valve Slide, Plate & Gasket Orientation: If the valve plate (item 10) and slide valve (item 9) are removed, ensure they are installed in the proper orientation. The flat face of the slide valve sits in the pocket of the valve carrier (item 4) so that the square cut out on the slide valve faces the smooth polished side of the valve plate

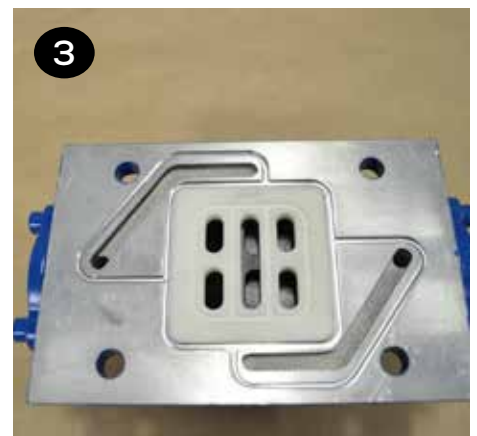
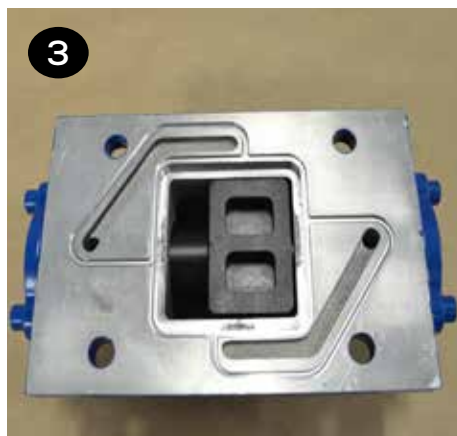
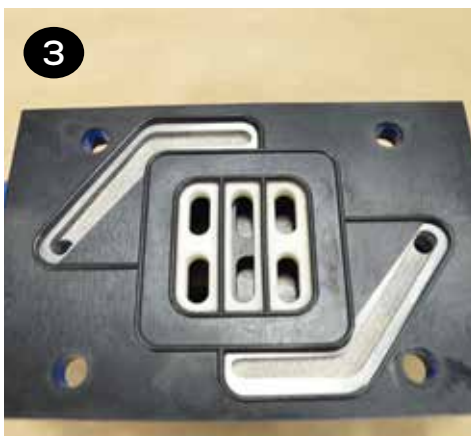

4 Insert the (4) cap screws & washers (items 1 & 2) through the valve body and gasket (items 3 & 36) and place onto the center section (item 35). Ensure the slide valve and valve plate (items 9 & 10) are in place and the valve sits flat on the center section.



5 Place the muffler gasket (item 37) over the (4) cap screws (item 1) on the back side of the center section (item 35) followed by the muffler plate and muffler (items 38 & 40).



6 Tighten and torque the (4) cap screws & washers (items 1 & 2) into the muffler plate.

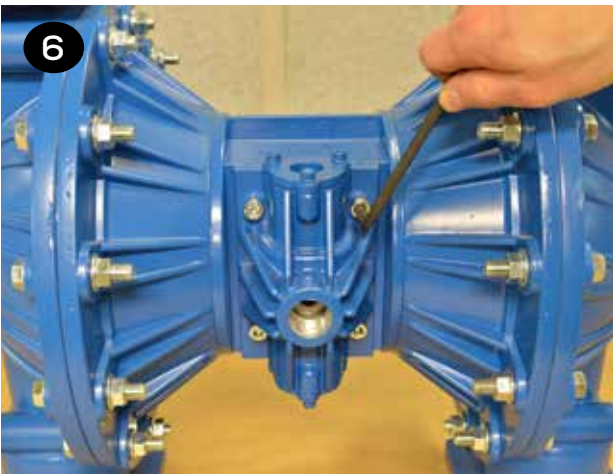

ITEM	DESCRIPTION	PART NO.	QTY	KIT
13	O-RING, VALVE SEAT, NEOPRENE	109313	8	W
	O-RING, VALVE SEAT, BUNA-N	109539		
	O-RING, VALVE SEAT, EPDM	109540		
	O-RING, VALVE SEAT, FKM	109419		
	O-RING, VALVE SEAT, PTFE	109318		
	O-RING, VALVE SEAT, FEP ENCAPSULATED FKM	109600		
14	VALVE SEAT, ALUMINUM - REQUIRES ITEM 13	109238	4	W
	VALVE SEAT, STAINLESS STEEL - REQUIRES ITEM 13	109242		
	VALVE SEAT, PTFE - REQUIRES ITEM 13	109597		
	VALVE SEAT, NEOPRENE (GREEN DOT)	109230		
	VALVE SEAT, BUNA-N (RED DOT)	109234		
	VALVE SEAT, EPDM (BLUE DOT)	109442		
	VALVE SEAT, FKM (WHITE OR SILVER DOT)	109288		
	VALVE SEAT, SANTOPRENE (RED)	109246		
	VALVE SEAT, HYTREL (CREAM)	109226		
	VALVE SEAT, POLYURETHANE (BEIGE)	109303		
15	VALVE BALL, NEOPRENE (GREEN DOT)	109205	4	W
	VALVE BALL, BUNA-N (RED DOT)	109209		
	VALVE BALL, EPDM (BLUE DOT)	109213		
	VALVE BALL, FKM (WHITE OR SILVER DOT)	109217		
	VALVE BALL, SANTOPRENE (RED)	109221		
	VALVE BALL, PTFE (WHITE)	109201		
18	LIQUID CHAMBER, ALUMINUM	109110	2	
	LIQUID CHAMBER, STAINLESS STEEL	109114		
19	OUTER PLATE, ALUMINUM - ONE PIECE, INCLUDES STUD	109161	2	
	OUTER PLATE, STAINLESS STEEL - REQUIRES ITEM 20	109165		
21	DIAPHRAGM, PTFE (WHITE) - REQUIRES BACK UP	109184	2	W
22	DIAPHRAGM, NEOPRENE (GREEN DOT)	109188-1	2	W
	DIAPHRAGM, BUNA-N (RED DOT)	109188-2		
	DIAPHRAGM, EPDM (BLUE DOT)	109188-3		
	DIAPHRAGM, FKM (WHITE OR SILVER DOT)	109188-4		
	DIAPHRAGM, SANTOPRENE (RED)	109196		
	DIAPHRAGM, HYTREL (CREAM)	109192		
	DIAPHRAGM, POLYURETHANE (BEIGE)	109437		
23	INNER PLATE	109170	2	
26	AIR CHAMBER, ALUIMINUM	109461	2	
	AIR CHAMBER, GF POLYPROPYLENE	109146		
28	O-RING, BUSHING OD	109420	4	A1/A2
29	SHAFT BUSHING	109180	2	A1/A2
30	O-RING, SHAFT	109424	6	A1/A2
31	BUMP STOP	109429	2	
32	SHAFT	109175	1	
33	O-RING, CENTER SECTION, LARGE	109434	2	A1/A2
34	O-RING, CENTER SECTION, SMALL	109418	2	A1/A2

ITEM	DESCRIPTION	PART NO.	QTY	KIT
35	CENTER SECTION, ALUMINUM	109460	1	-
	CENTER SECTION, GF POLYPROPYLENE	109151		-
36	GASKET, AIR VALVE	109267	1	A1/A2/V1/V2
37	GASKET, MUFFLER	109428	1	A1/A2/V1/V2
38	MUFFLER PLATE	109271	1	-
	MUFFLER PLATE ATEX	109271-1	1	-
39	MANIFOLD, DISCHARGE, ALUMIUM	SEE MANIFOLD TABLES		-
	MANIFOLD, DISCHARGE, STAINLESS STEEL			-
40	MUFFLER	109562	1	-
	MUFFLER ATEX	109700	1	-
42	SPLIT FLANGE HALF	SEE MANIFOLD TABLES		-
43	GROUNDING LUG	108091	1	-

KIT COLUMN KEY:

W - PARTS SUPPLIED IN A WET SIDE KITS

A1 - PARTS SUPPLIED IN PLASTIC VALVE AIR END KIT 109674

A2 - PARTS SUPPLIED IN ALUMINUM VALVE AIR END KIT 109596

V1 - PARTS SUPPLIED IN PLASTIC REPLACEMENT VALVE KIT 109677

V2 - PARTS SUPPLIED IN ALUMINUM REPLACEMENT VALVE KIT 109590

PUMPS FITTED WITH GFRPP AIR VALVES FT20_-P-_-_-				
ITEM	DESCRIPTION	PART NO.	QTY	KIT
3	VALVE BODY, GFRPP	109251	1	V1
4	VALVE CARRIER WITH SEALS	109655	1	V1
5	VALVE CAP O-RING	109644	1	A1/V1
6	VALVE CAP, GFRPP	109275	1	V1
8	RETAINING RING, HO-165 SS	109645	1	V1

PUMPS FITTED WITH ALUMINUM AIR VALVES FT20_-A-_-_-				
ITEM	DESCRIPTION	PART NO.	QTY	KIT
3	VALVE BODY, ALUMINUM	SEE ITEM 41	1	V2
4	VALVE CARRIER, ALUMINUM	109456	1	V2
5	VALVE CAP O-RING	109416	2	A2/V2
6	VALVE CAP, ALUMINUM	SEE ITEM 41	2	V2
7	CAP SCREW, SOC. HD M6X1.0X16	109513	6	V2
41	CONTAINS ITEMS 3, ,4, 5, 6, & 7	109593	1	V2

SUCTION MANIFOLD (ITEM 12)						
LAST 2 DIGITS OF MODEL NUMBER						
BEGINNING OF MODEL NUMBER	N2		B2		F2	
	PART NO.	QTY	PART NO.	QTY	PART NO.	QTY
FT20A - ITEM 12	109278	1	109278-1	1	N/A	-
FT20S - ITEM 12	109279	1	109279-1	1	109279	1
ITEM 42(NOT SHOWN)	N/A	-	N/A	-	109633	2

DISCHARGE MANIFOLD (ITEM 39)						
LAST 2 DIGITS OF MODEL NUMBER						
BEGINNING OF MODEL NUMBER	N2		B2		F2	
	PART NO.	QTY	PART NO.	QTY	PART NO.	QTY
FT20A - ITEM 39	109282	1	109282-1	1	N/A	-
FT20S - ITEM 39	109283	1	109283-1	1	109283	1
ITEM 42 (NOT SHOWN)	N/A	-	N/A	-	109633	2

FT20A & FT20S Maximum Torque Settings*			
Stainless Steel Pumps		Aluminum Pumps	
Item #	Torque	Item #	Torque
1	8.5 N-m (75 in-lbs)+	1	10N-m (90 in-lbs)
7	8 N-m (72 in-lbs)	7	8 N-m (72 in-lbs)
11	38 N-m (336 in-lbs)+	11	46 N-m (408 in-lbs)
16	38 N-m (336 in-lbs)+	16	46 N-m (408 in-lbs)
17	38 N-m (336 in-lbs)+	17	46 N-m (408 in-lbs)
19	91 N-m (800 in-lbs)+	19	91 N-m (800 in-lbs)+
24	20 N-m (180 in-lbs)	24	20 N-m (180 in-lbs)

Asterisk (*) from the exploded view diagram indicates fasteners to be torqued. Stainless steel to stainless steel fasteners should be lubricated to prevent galling. A Plus sign (+) on the above torque values indicates a lubricated fastener.

MODEL FT20A HARDWARE

ITEM	NON-WETTED MATERIAL	DESCRIPTION	PART NO.	QTY
1	A	CAP SCREW, SOCKET HD M8X1.25X120MM	109495	4
	P			
2	A	WASHER, LOCK M8 HIGH-COLLAR	109493	4
	P			
11	A	CAP SCREW, HEX HD FLNG M10X1.5 X 35MM	109476	16
	P			
16	A	CAP SCREW, HEX HD FLNG M10X1.5 X 55MM	109477	16
	P			
17	A	CAP SCREW, HEX HD FLNG M10X1.5X130MM	109479	8
	P			
24	A	CAP SCREW, HEX HD M8X1.25X30MM	109471	8
	P	CAP SCREW, HEX HD M8X1.25X160MM	109473	4
25	A	WASHER, FLAT M8	109469	8
	P			
27	A	NUT, HEX FLNG M10X1.5	109485	24
	P			
44	A	N/A	-	-
	P	NUT, HEX M8X1.25 (FOR CENTER SECTION TO AIR CHAMBER - NOT SHOWN)	109474	4

MODEL FT20S HARDWARE

ITEM	NON-WETTED MATERIAL	DESCRIPTION	PART NO.	QTY
1	A	CAP SCREW, SOCKET HD M8X1.25 X 120MM SS	109520	4
	P			
2	A	WASHER, LOCK M8 HIGH-COLLAR SS	109518	4
	P			
11	A	CAP SCREW, HEX HD FLNG M10X1.5 X 30MM SS	109497	16
	P			
16	A	CAP SCREW, HEX HD FLNG M10X1.5 X 50MM SS	109498	16
	P	CAP SCREW, HEX HD FLNG M10X1.5 X 55MM SS	109499	
17	A	CAP SCREW, HEX HD FLNG M10X1.5X130MM SS	109500	8
	P			
20	A	DOUBLE END STUD, M16X2.0X50MM	109523	2
	P			
24	A	CAP SCREW, HEX HD M8X1.25X30MM	109471	8
	P	CAP SCREW, HEX HD M8X1.25X160MM	109473	4
25	A	WASHER, FLAT M8	109469	8
	P			
27	A	NUT, HEX FLNG M10X1.5 SS	109509	24
	P			
44	A	N/A	-	-
	P	NUT, HEX M8X1.25 (FOR CENTER SECTION TO AIR CHAMBER - NOT SHOWN)	109474	4

Warranty



P.H.A.'R warrants this pump product to be free of defects in materials and workmanship for a period of five years from date of purchase by original purchaser. If a warranted defect, which is determined by manufacturer's inspection, occurs within this period, it will be repaired or replaced at the manufacturer's option, provided (1) the product is submitted with proof of purchase date and (2) transportation charges are prepaid to the manufacturer.

Liability under this warranty is expressly limited to repairing or replacing the product or parts thereof and is in lieu of any other warranties, either expressed or implied. This warranty does apply only to normal wear of the product or components. This warranty does not apply to products or parts broken due to, in whole or in part, accident, overload, abuse, chemical attack, tampering, or alteration. The warranty does not apply to any other equipment used or purchased in combination with this product. The manufacturer accepts no responsibility for product damage or personal injuries sustained when the product is modified in any way. If this warranty does not apply, the purchaser shall bear all cost for labor, material and transportation.

Manufacturer shall not be liable for incidental or consequential damages including, but not limited to process down time, transportation costs, costs associated with replacement or substitution products, labor costs, product installation or removal costs, or loss of profit. In any and all events, manufacturer's liability shall not exceed the purchase price of the product and/or accessories



P.H.A. SAS
14 Z.A. Les Piboules
84300 Les Taillades - France
P: 04 90 78 19 99
www.pha.fr